

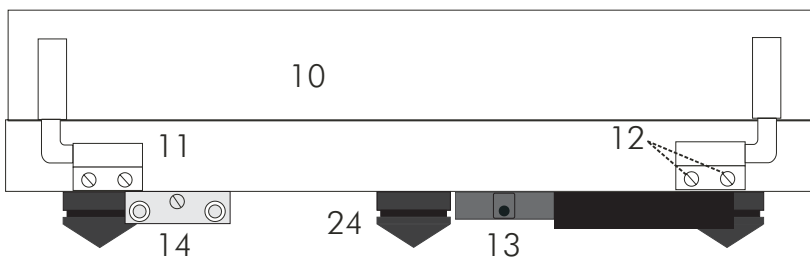

INSTRUCTIONS FOR USE
Pro-Ject Debut SE II

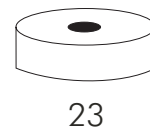
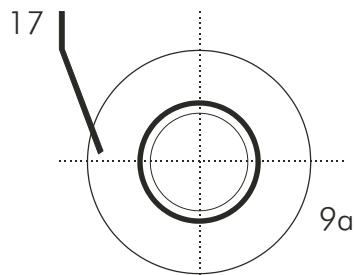
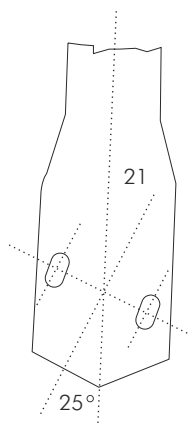
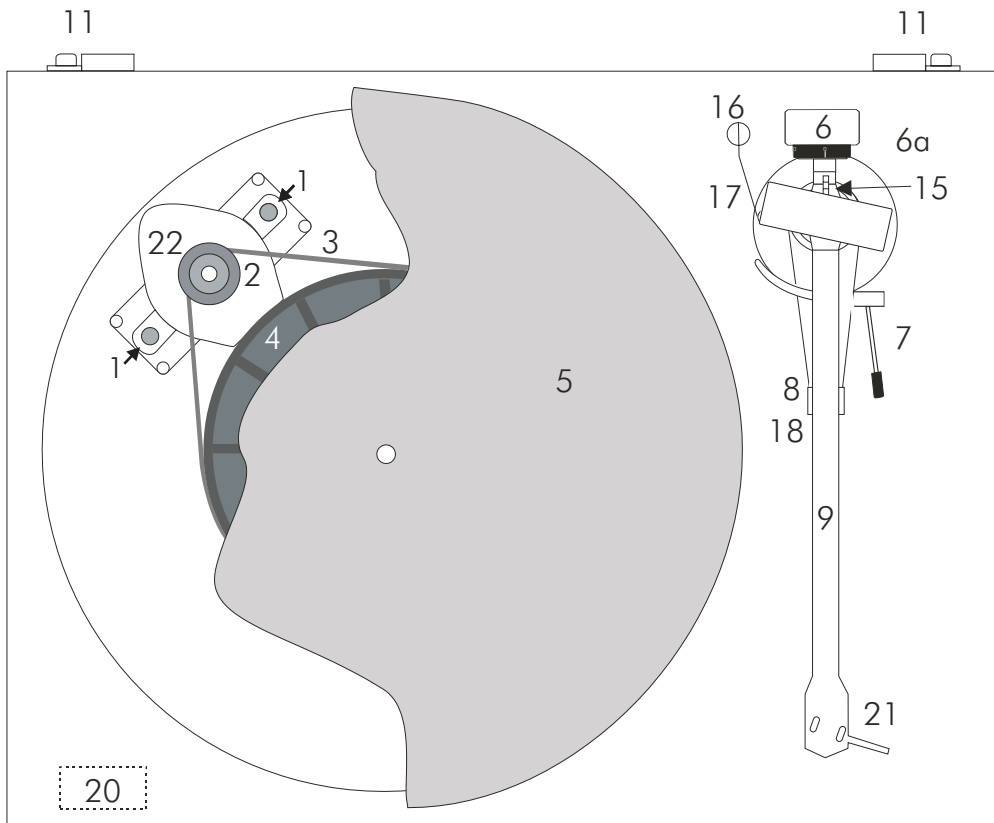

PRO-JECT DEBUT SE II

Controls, features and connections

- | | | | |
|------|---|----|-----------------|
| 1 | Motor transportation screw (marked red) | | |
| 2 | Stepped drive pulley | | |
| 3 | Drive belt * | 3a | Hook * |
| 4 | Hub | | |
| 5 | Platter with felt mat * | | |
| 6 | Tonearm counterweight * | 6a | Downforce scale |
| 7 | Tonearm lift lever | | |
| 8/18 | Tonearm rest and removable transport lock | | |
| 9 | Tonearm tube | 9a | Tonearm base |
| 10 | Lid * | | |
| 11 | Lid hinges | | |
| 12 | Hinge fasteners | | |
| 13 | Power supply socket | | |
| 14 | Phono output sockets and earth connection | | |
| 15 | Anti-skating weight adjustment scale | | |
| 16 | Anti-skating weight * | | |
| 17 | Anti-skating weight support hoop | | |
| 20 | Power switch | | |
| 21 | Headshell with finger lift and fitted Ortofon 510 mk II cartridge | | |
| 22 | Motor | | |
| 23 | Single adapter * | | |
| 24 | Adjustable tip-toe feet with anti-scratch cups * | | |
| | Connection cable (not shown) * | | |
| | Power supply (not shown) * | | |

Dear music lover,

thank you for purchasing a PRO-JECT AUDIO record player.

In order to achieve maximum performance and reliability with this record player you should study these instructions for use carefully.



Warning of a hazard for the user, the unit or possible misuse.



Important notice.

**** Your turntable has been delivered with a factory fitted and adjusted cartridge, please ignore the cartridge set up instructions unless changing the cartridge at a later date.**

During assembly and adjustment of the deck small parts could be lost if not carefully placed in a suitable receptacle. Before starting assembly make yourself acquainted with the parts listed above and correspondingly numbered in the technical drawings above. Separately packed items are marked with an asterisk *.

Set-up

Make sure the surface you wish to use the turntable on is level (use a spirit level) before placing the turntable on it. Fit the platter (5) and felt mat over the spindle of the hub (4).

Level the plinth using a spirit level and the adjustable feet (24). Remove the two red transport screws (1) which secure the motor (22) during transportation.

Remove the transport lock (18) from the tonearm. Store it together with the two red motor transport screws (1) in the original packaging so they are available for any future transportation.

Fit the drive belt (3) around the hub (4) and the smaller diameter part of the motor pulley (2). Avoid getting sweat or grease on the belt as these will deteriorate the performance and reduce the belt's lifespan. Use absorbent kitchen paper to remove any oil or grease from the outer edge of the hub and the belt. Fit the platter (5) and felt mat over the spindle of the hub (4).

Cartridge downforce adjustment

The counterweight (6) supplied is suitable for cartridges weighing between 3,5 - 5,5g. Alternative counterweights for cartridges weighing between 6 - 9g or 1,5 - 3g are available as accessory parts. Adjust the downforce prior to installing the anti-skating weight.

Pushing carefully, turn the counterweight (6) onto the rear end of the tonearm tube (9), and so that the downforce scale (6a) shows towards the front of the player. Lower the armlift and position the cartridge in the space between arm rest and platter. Carefully rotate the counterweight (6) until the armtube balances out. The arm should return to the balanced position if it is moved up or down. This adjustment must be done carefully. Do not forget to remove the cartridge protection cap if fitted.

Once the arm is correctly balanced return it to the rest. Hold the counterweight (6) without moving it, and gently revolve the downforce scale ring (6a) until the zero is in line with the anti-skating prong (15). Check whether the arm still balances out.

Rotate the counterweight counter clockwise (seen from the front) to adjust the downforce according to the cartridge manufacturer's recommendations. One mark on the scale represents 1 mN (= 0,1g / 0,1 Pond) of downforce.



The recommended downforce for the factory fitted cartridge is **15mN**.

Anti-skating force adjustment

The anti-skating force must be adjusted according to the mass of the cartridge as follows:

<u>Downforce</u>	<u>Groove in the stub (15)</u>
10 - 14mN	1 st from bearing rings
15 - 19mN	2 nd " " "
20mN and bigger	3 rd " " "

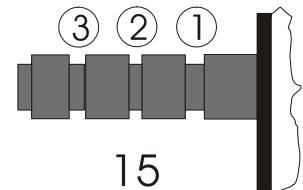

Slip the loop of the anti-skating weight's thread over the third groove of the stub to set the correct anti-skating force for the factory-fitted cartridge. Feed the thread through the loop of the wire support (17).

Connection to the amplifier

The record player has gold plated female RCA phono sockets (14) so you can substitute the interconnect cables supplied with those of your choice for connection to the amplifier if you wish. Your dealer can advise you on alternative cables. Use the Phono input (sometimes labelled gram, disc or RIAA) on your amplifier. Make sure that the phono input offers correct matching and amplification for the type of cartridge used. Line inputs (such as CD, Tuner, Tape or Video) are not suitable.

Take care to connect the left and right channels correctly. The right channel is usually marked red, the left channel black or white. Check the manual supplied with your amplifier for relevant information. The earthing wire of the tonearm lead should be connected to the earth terminal on your amplifier (if provided).

If your amplifier does not have an input suitable for phono cartridges you will require a separate phono amplifier stage for MM or MC cartridges such as the PRO-JECT PHONO BOX or the PRO-JECT TUBE BOX which is then connected between the record player and a free line level input of the amplifier.

For detailed product information please refer to the Pro-Ject web site www.project-audio.com.



The recommended load resistance for the factory fitted cartridge is: **47kohms/MM-input**

Mains power connection

The turntable is supplied with a power supply suitable for your country's mains supply. Check the label before connecting to ensure compliance with the mains rating in your house.

Connect the low voltage plug from the power supply to the socket (13) on the rear of the record player before connecting the power supply to the mains.

Fitting the lid

Fit the lid (dust cover 10) carefully over the hinge prongs and adjust the screws (12) until the lid stays open where you want it to without being too stiff to open or close.

Switching on and off

Pressing the power switch (20) alternately starts or stops the motor.

Changing replay speed

To play records at 45 r.p.m. first remove the platter (5). Using the accessory tool provided (3a), hook the belt (3) over the larger diameter part of the motor pulley (2). Refit the platter. To revert to 33,33 r.p.m. repeat the proceedings using the smaller step on the pulley.



*When the Pro-Ject Speed Box or the Speed Box SE are used speed change between 33 and 45 r.p.m. is electronic. There is no need to move the belt manually. For further information see the last page.
*** In addition, 78 r.p.m. is available after fitting a special pulley, which may be purchased as an optional extra.*

For detailed product information please refer to the Pro-Ject web site www.project-audio.com.

Maintenance and cleaning

Your record player requires little or no regular maintenance. Remove dust with a slightly moistened antistatic cloth. Never use a dry cloth because this will create static electricity which attract more dust! Antistatic cleaning fluids are available at specialist stores but must be applied sparingly to avoid damage to rubber parts. It is recommended to fit the needle cover before cleaning or maintenance is carried out to avoid damage. If the player is not used over a long period of time the drive belt can be removed to prevent unequal stretching.



Always disconnect the record player from the mains power supply as a precaution before maintenance!

Useful tips

The record player should be positioned on a low-resonance surface such as wood or multiple layer ply board to avoid structural vibrations disturbing replay.

Fitting and connecting the cartridge

** All cartridges with half inch mounting holes can be fitted. Leaving the needle's protection cover on, fit the cartridge to the headshell using the screws supplied with the cartridge by passing one screw through each slot in the headshell (21). Do not tighten the nuts yet.

Connect the tonearm wires to the cartridge pins as follows:

white	left channel positive (L+)
red	right channel pos. (R+)
green	right channel return (R -)
blue	left channel return (L -)

The full sound quality of the record player can only be achieved if the cartridge is correctly adjusted. Particular tools like the PRO-JECT alignment tool are required to accomplish this job properly.

If you are not well acquainted with the adjustment of cartridges you are advised to call upon the willing help of your PRO-JECT dealer to accomplish this task for you.

Adjusting the azimuth

** The cartridge needle must be vertical in the record groove in order to trace the groove wall modulations correctly.

A small screw at the bearing end of the arm allows incorrect azimuth to be corrected if your needle is not mounted exactly perpendicular to the cartridge body (which is often the case).

Slacken off the screw just enough to be able to revolve the arm tube without applying force. Note! Do not remove the screw completely!

With the aid of a good magnifying glass adjust the needle until it is vertical in the groove (i.e. perpendicular to the record's surface). Ideally this should correspond to the top surface of the cartridge body being parallel to the record surface. When you are satisfied that the needle is vertical retighten the screw carefully.



Under no circumstances should the arm tube be adjusted with the needle still in the record groove! Irreparable damage may be caused to the cantilever suspension! The arm must be lifted to make each adjustment and lowered afterwards to check it.

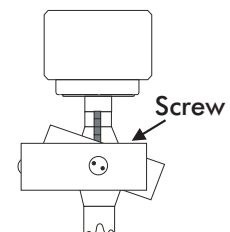

Technical specifications PRO-JECT DEBUT SE II

Nominal speeds	33,33/45,11 r.p.m.. *** 78 r.p.m. optional
Speed variance	±0,8 %
Wow and flutter	±0,12 %
Signal to noise	-65dB
Downforce range	10-30mN
Effective tonearm length	8,6 " (218,5mm)
Overhang	18,5mm
Power consumption	2W
Outboard power supply	16V/500mA AC, suitable for your country's mains supply
Dimensions (W x H x D)	415 x 118 x 320mm, dust cover open 415 x 365 x 405mm
Weight	6,9kg

Potential incorrect use and fault conditions

PRO-JECT turntables are manufactured to the highest standards and undergo strict quality controls before leaving the factory. Faults that may possibly occur are not necessarily due to material or production faults but can sometimes be caused by incorrect use or unfortunate circumstances. Therefore the following list of common fault symptoms is included.

The platter doesn't turn although the unit is switched on:

- The unit is not connected to the mains power supply.
- No mains at the socket.
- Drive belt is not fitted or has slipped off.

No signal through one or other channel or both channels:

- No signal contact from the cartridge to the internal tonearm wiring or from that to the arm lead or from that to the phono box or between that and the amplifier. This could be due to a faulty plug, broken wire or solder joint or simply loose plug/socket connection.
- Phono input not selected at amplifier.
- Amplifier not switched on.
- Amplifier or speakers defective or muted.
- No connection to the loudspeakers.

Strong hum on phono input:

- No earth connection from cartridge or arm or arm cable to amplifier, or earth loop.

Distorted or inconsistent sound from one or both channels:

- Record player is connected to wrong input of amplifier, or MM/MC switch incorrectly set.
- Needle or cantilever damaged.
- Wrong r.p.m., drive belt overstretched or dirty, platter bearing without oil, dirty or damaged.

Service

Should you encounter a problem which you are not able to alleviate or identify despite the above information, please contact your dealer for further advice. Only when the problem cannot be resolved there should the unit be sent to the responsible distributor in your country.

Guarantee repairs will only be effected if the unit is returned correctly packaged. For this reason we recommend keeping the original packaging. Never return a record player without making sure that it is safely disassembled and correctly packaged in the original packaging according to the diagrams on the last page of this user guide. Please remove these parts and pack them separately: lid (10), counterweight (6), anti-skating weight (16) platter (5), cartridge and belt (3). Fit the cartridge protection cap. Insert the transport screws for the motor (1) and the transport lock for the tonearm (18) prior to carefully packaging the record player.

Warranty



The manufacturer accepts no responsibility for damage caused by not adhering to these instructions for use and/or by transportation without the original packaging. Modification or change to any part of the product by unauthorized persons release the manufacturer from any liability over and above the lawful rights of the customer.

PRO-JECT is a Registered Trademark of H. Lichtenegger.

This guide was produced by: Audio Trade GmbH
Copyright © 2007. All rights reserved.

The information was correct at the time of going to press. The manufacturer reserves the right to make changes to the technical specification without prior notice as deemed necessary to uphold the ongoing process of technical development.

